

uitwerkbijlage

Naam kandidaat _____

Kandidaatnummer _____

1

a

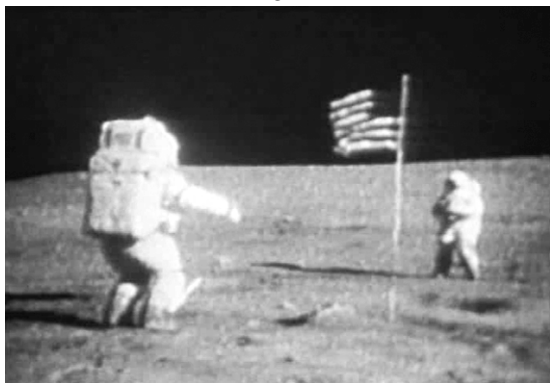

b

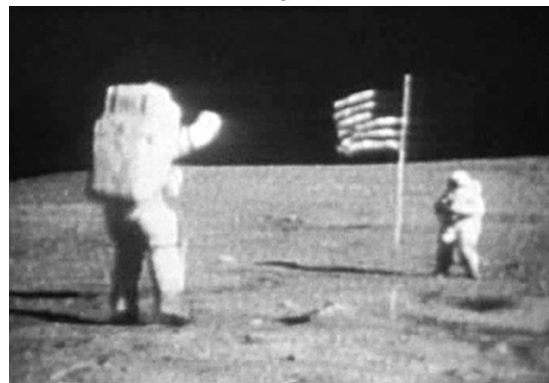

c

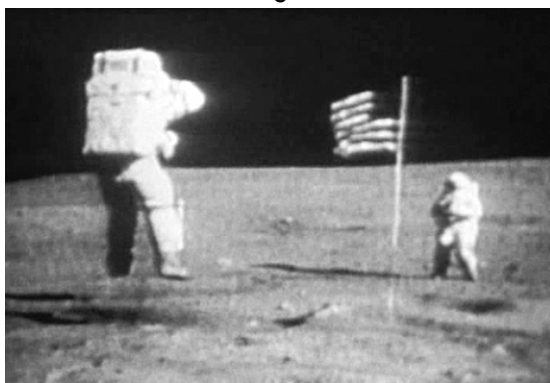

d

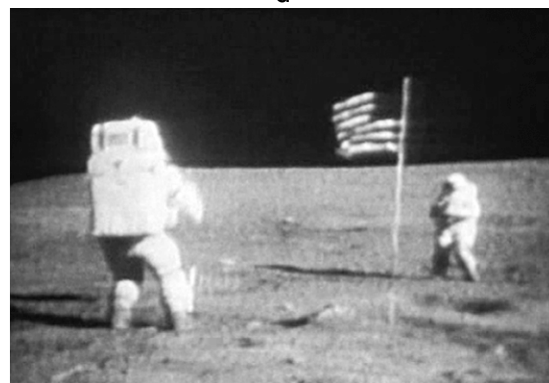

- 8 Maak de zinnen compleet zodat er juiste beweringen ontstaan.
- Als de spanning van de spanningsbron lager is dan de drempelspanning, is de stroomsterkte in de schakeling A.
 - De spanning over de weerstand is V.
 - De spanning over de LED is de spanning van de spanningsbron.

10

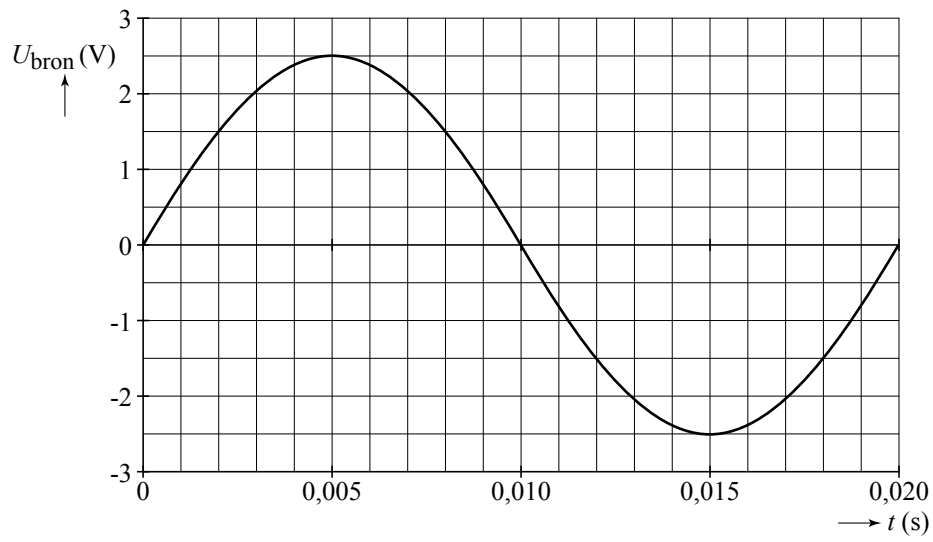

ruimte voor de bepaling van het percentage van de tijd dat de LED stroom doorlaat:

.....

.....

.....

.....

.....

.....

.....

19

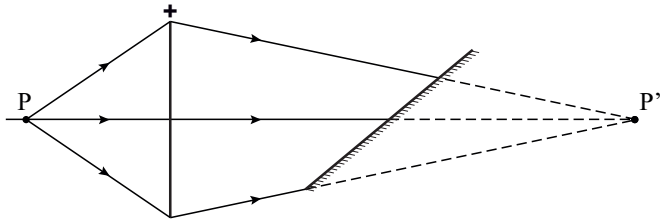

21

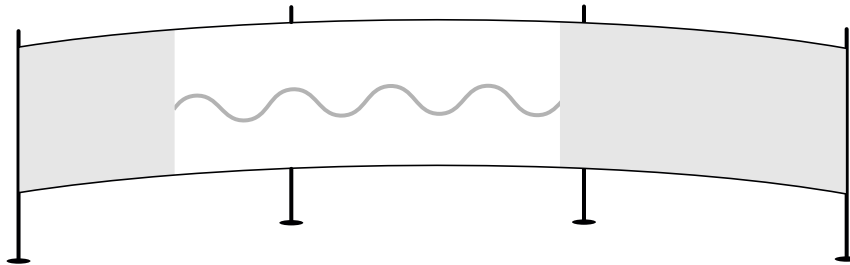

22

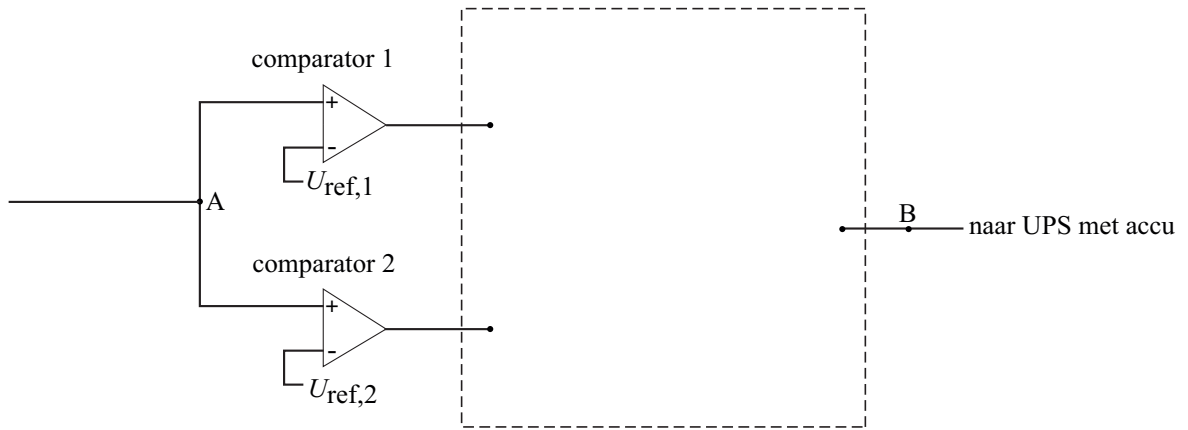

$U_{ref,1} = \dots\dots\dots V$

$U_{ref,2} = \dots\dots\dots V$

23

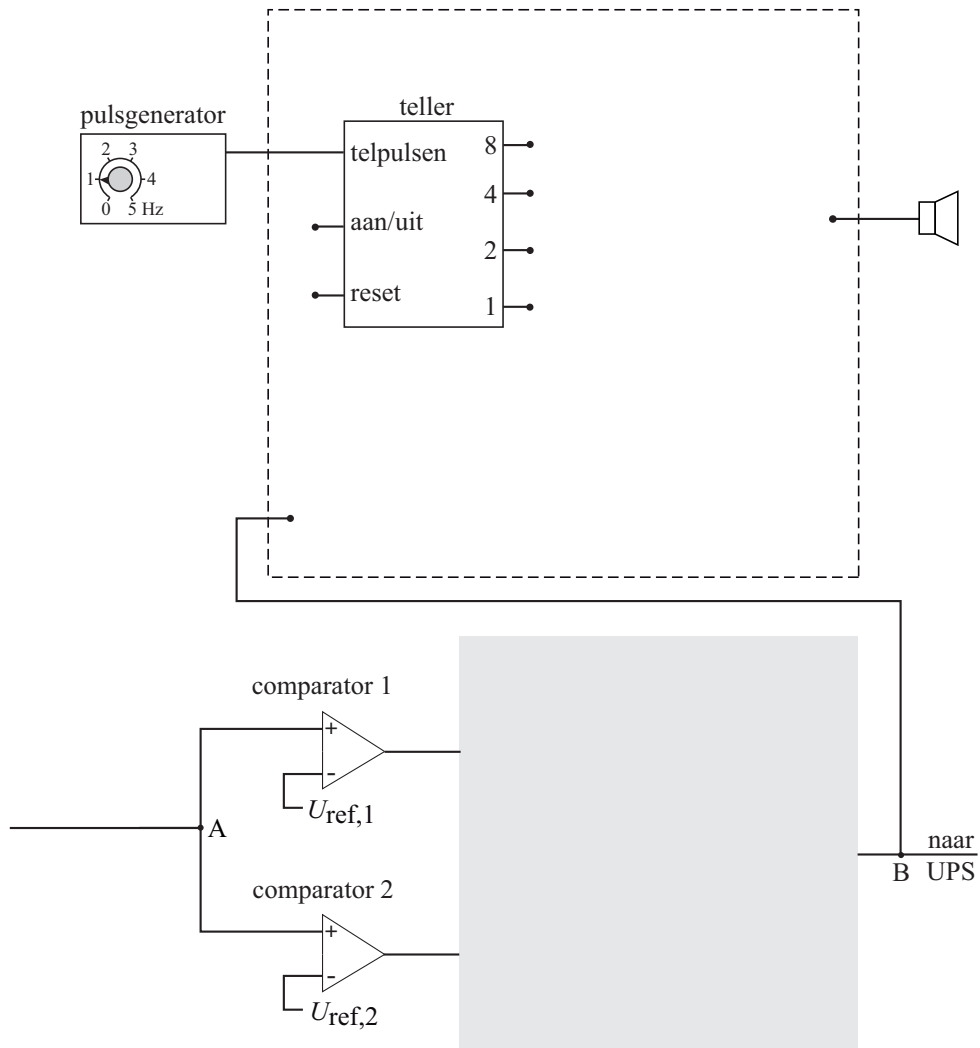

VERGEET NIET DEZE UITWERKBIJLAGE IN TE LEVEREN